



INSTRUCTIONS D'ASSEMBLAGE
ASSEMBLY INSTRUCTIONS

MONARCH
SPECIALTIES INC.

I 3467

TABLE D'APPOINT -
25"H / NOIR / METAL NOIR

ACCENT TABLE -
25"H / BLACK / BLACK METAL



**POUR DE L'ASSISTANCE OU POUR COMMANDER
DES PIÈCES CONTACTEZ NOTRE DÉPARTEMENT
DE SERVICE À LA CLIENTÈLE.**

**FOR ASSISTANCE OR TO ORDER PARTS
CONTACT OUR CUSTOMER SERVICE DEPARTMENT**

WWW.MONARCHSERVICE.COM

LISTE DES PIÈCES
PARTS LIST

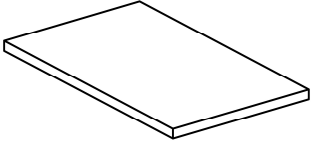
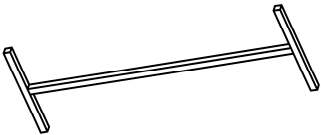
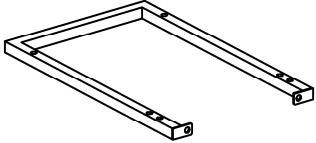
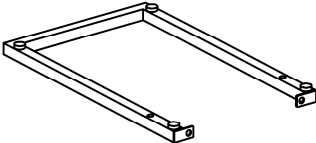
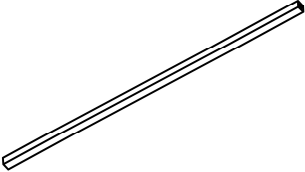
PIÈCE / PART #	IMAGE	DESCRIPTION	QTY / QTÉ
1		<p align="center">TABLE TOP SURFACE DE TABLE</p>	1
2		<p align="center">BACK FRAME CADRE DU DOSSIER</p>	1
3		<p align="center">TOP FRAME CADRE DE SURFACE</p>	1
4		<p align="center">BOTTOM FRAME CADRE DU BAS</p>	1
5		<p align="center">SUPPORT BAR BARRE DE SOUTIEN</p>	2

LISTE DES PIÈCES DE MONTAGE
HARDWARE LIST

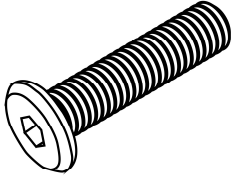
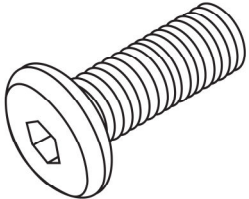
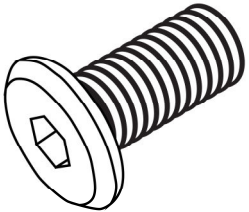
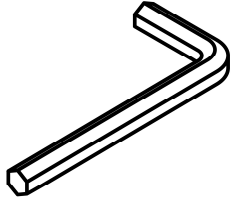
PIÈCE / PART #	IMAGE	DESCRIPTION	QTY / QTÉ
A		<p align="center">ASSEMBLING BOLT - Ø 1/4" X 1 1/8"</p> <p align="center">BOULON D'ASSEMBLAGE - Ø 1/4" X 1 1/8"</p>	4
B		<p align="center">ASSEMBLING SCREW - Ø 1/4" X 1"</p> <p align="center">VIS D'ASSEMBLAGE - Ø 1/4" X 1"</p>	4
C		<p align="center">ASSEMBLING BOLT - Ø 1/4" X 1/2"</p> <p align="center">BOULON D'ASSEMBLAGE - Ø 1/4" X 1/2"</p>	4
D		<p align="center">HEX KEY</p> <p align="center">CLÉ HEXAGONALE</p>	1



OUTIL DE VÉRIFICATION DE DIMENSIONS DES PIÈCES
HARDWARE DIMENSIONS VERIFICATION TOOL



ÉTAPE / STEP 1

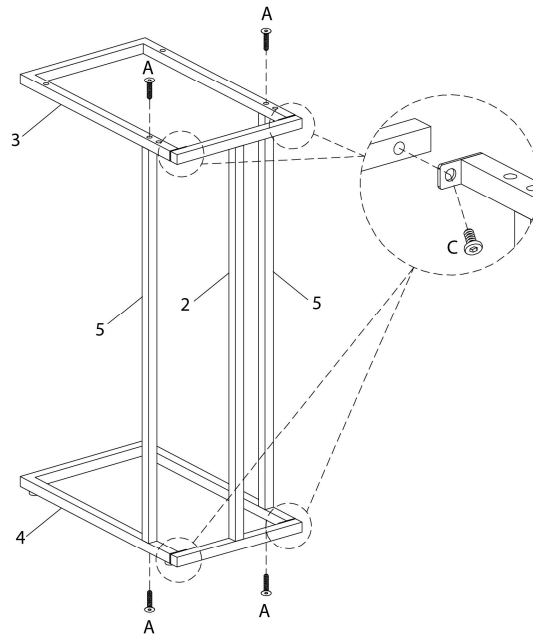

ÉTAPE / STEP 2

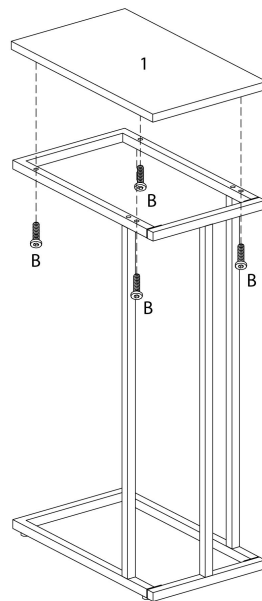

ÉTAPE / STEP 3

